

Major Ratings and Characteristics

Characteristics	95SQ015	Units
$I_{F(AV)}$ Rectangular waveform	9	A
V_{RRM}	15	V
I_{FSM} @tp=5µs sine	2900	A
V_F @9Apk, $T_J=75^\circ\text{C}$	0.25	V
T_J range	-55to100	$^\circ\text{C}$

Description/Features

The 95SQ015 axial leaded Schottky rectifier has been optimized for ultra low forward voltage drop specifically for the OR-ing of parallel power supplies. The proprietary barrier technology allows for reliable operation up to 100° C junction temperature. Typical applications are in parallel switching power supplies, converters, reverse battery protection, and redundant power subsystems.

- 125° C T_J operation ($V_R < 5V$)
- Optimized for OR-ing applications
- Ultra low forward voltage drop
- High frequency operation
- Guard ring for enhanced ruggedness and long term reliability
- High purity, high temperature epoxy encapsulation for enhanced mechanical strength and moisture resistance

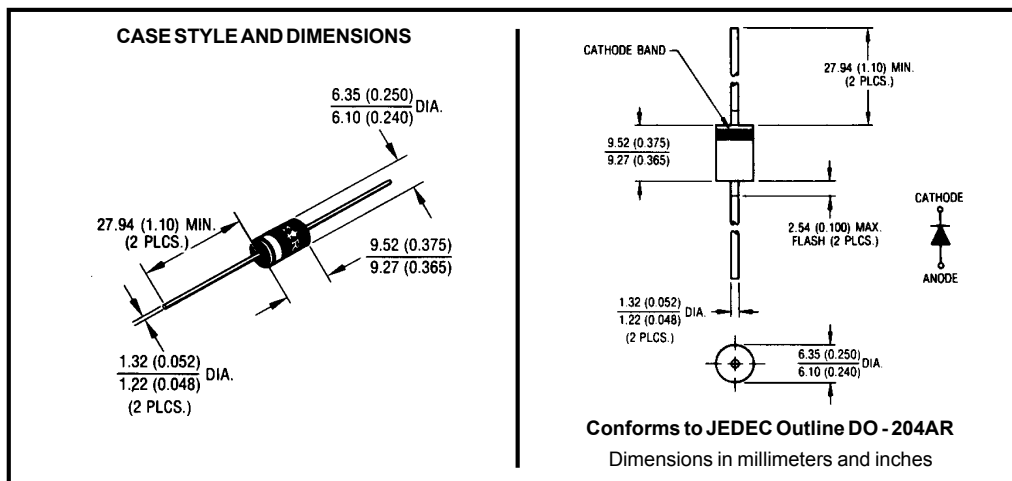

Voltage Ratings

Part number	95SQ015
V_R Max. DC Reverse Voltage (V)	15
V_{RWM} Max. Working Peak Reverse Voltage (V)	25

Absolute Maximum Ratings

Parameters	95SQ	Units	Conditions
$I_{F(AV)}$ Max. Average Forward Current * See Fig. 5	9	A	50% duty cycle @ $T_C = 55^\circ\text{C}$, rectangular wave form
I_{FSM} Max. Peak One Cycle Non-Repetitive Surge Current * See Fig. 7	2900	A	5 μs Sine or 3 μs Rect. pulse
	400		10ms Sine or 6ms Rect. pulse
E_{AS} Non-Repetitive Avalanche Energy	4.50	mJ	$T_J = 25^\circ\text{C}$, $I_{AS} = 1$ Amps, $L = 9$ mH
I_{AR} Repetitive Avalanche Current	1	A	Current decaying linearly to zero in 1 μsec Frequency limited by T_J max. $V_A = 3 \times V_R$ typical

Electrical Specifications

Parameters	95SQ	Units	Conditions
V_{FM} Max. Forward Voltage Drop (1) * See Fig. 1	0.31	V	@ 9A
	0.37	V	@ 18A
	0.25	V	@ 9A
	0.31	V	@ 18A
I_{RM} Max. Reverse Leakage Current (1) * See Fig. 2	7	mA	$T_J = 25^\circ\text{C}$
	348	mA	$T_J = 100^\circ\text{C}$
	310	mA	$T_J = 100^\circ\text{C}$
	190	mA	$T_J = 100^\circ\text{C}$
C_T Max. Junction Capacitance	1300	pF	$V_R = 5V_{DC}$, (test signal range 100Khz to 1Mhz) 25°C
L_S Typical Series Inductance	10.0	nH	Measured lead to lead 5mm from body
dv/dt Max. Voltage Rate of Change (Rated V_R)	10,000	V/ μs	

(1) Pulse Width < 300 μs , Duty Cycle < 2%

Thermal-Mechanical Specifications

Parameters	95SQ	Units	Conditions
T_J Max. Junction Temperature Range	-55 to 125	$^\circ\text{C}$	
T_{stg} Max. Storage Temperature Range	-55 to 150	$^\circ\text{C}$	
R_{thJL} Max. Thermal Resistance Junction to Lead	8.0	$^\circ\text{C/W}$	DC operation * See Fig. 4 1/8 inch lead length
R_{thJA} Typical Thermal Resistance, Junction to Air	44	$^\circ\text{C/W}$	
wt Approximate Weight	1.4(0.049)	g(oz.)	
Case Style	DO-204AR	JEDEC	

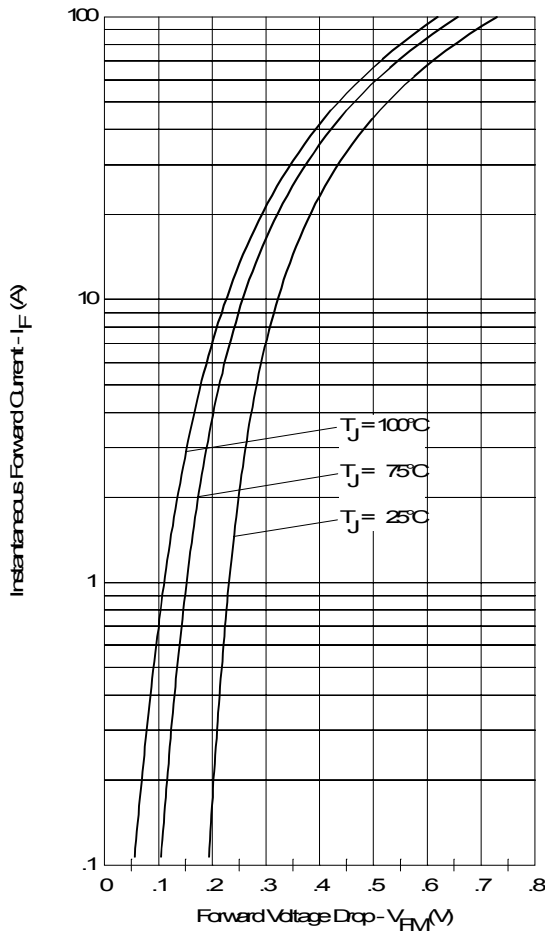

Fig. 1 - Maximum Forward Voltage Drop Characteristics

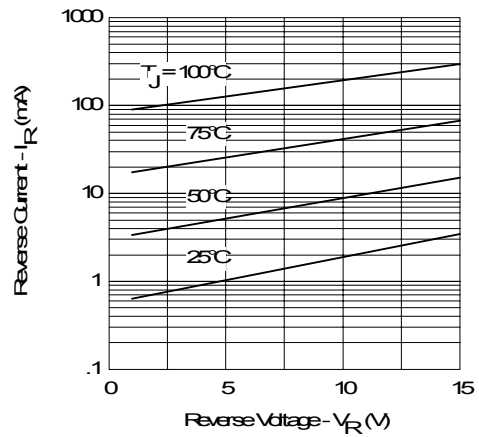

Fig. 2 - Typical Values of Reverse Current Vs. Reverse Voltage

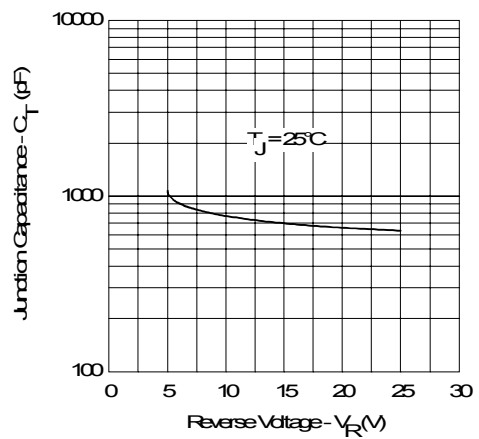

Fig. 3 - Typical Junction Capacitance Vs. Reverse Voltage

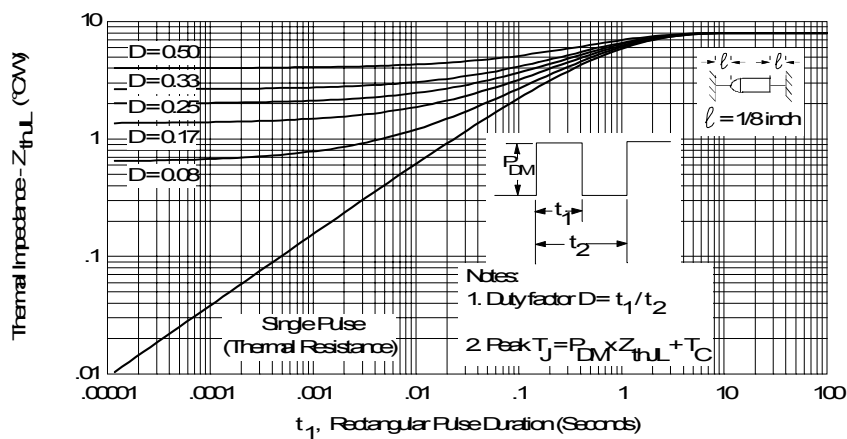

Fig. 4 - Maximum Thermal Impedance Z_{thJL} Characteristics

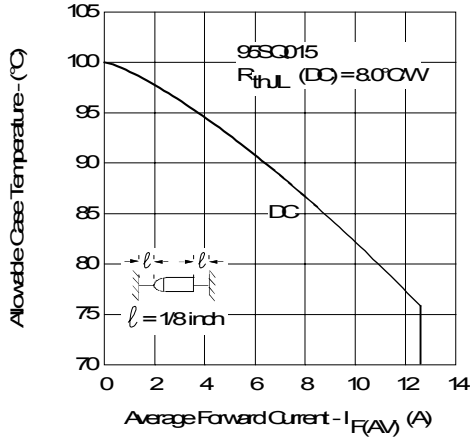

Fig. 5 - Maximum Allowable Case Temperature Vs. Average Forward Current

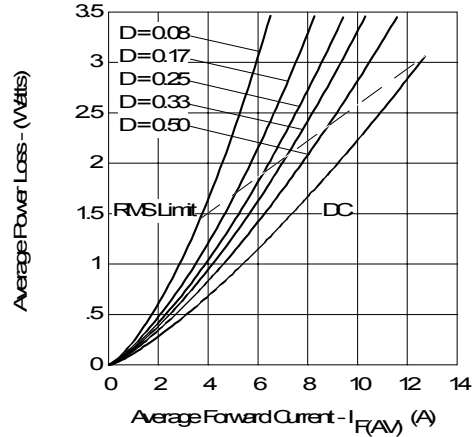

Fig. 6 - Forward Power Loss Characteristics

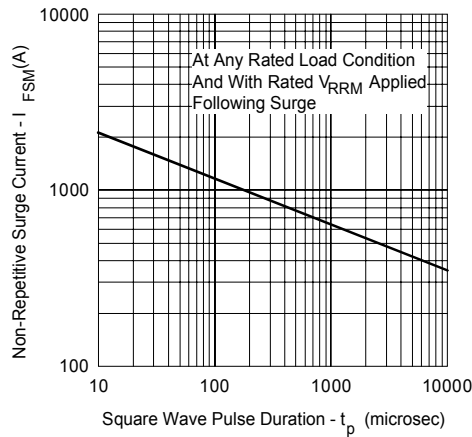

Fig. 7 - Maximum Non-Repetitive Surge Current

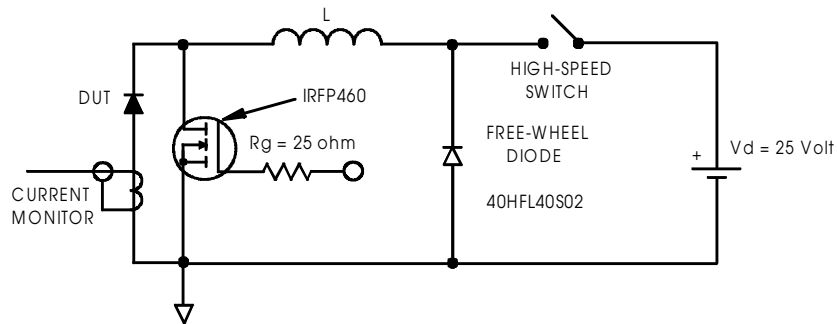

Fig. 8 - Unclamped Inductive Test Circuit